

Micro-DCI Communication Services 53SU6000

- Communications Interface Software for Micro-DCI controllers
 - Microsoft Windows 2000 Professional and XP Professional compatible
- Multiple network support
 - up to 4 Serial Ports
 - up to 4 Supervisor Ports
 - up to 8 Ethernet E-Ports
 - EP1000 E-Port Ethernet/DataLink Gateway Support
 - MicroDCI DataLink and MircoLink Support
 - Up to 2 local virtual networks
- Communication Network Wizard
- OPC 2.0 Compliant Server
- Dynamic Data Exchange (DDE) Support
- Automatic Tag recognition
- Basic Controller Configuration
- Local Supervisor card emulation, PC FTRAN support
- Support for previous generation MicroDCI controller products
- Ethernet based Remote Communication Network support
- Direct access to MicroTools and LoopMaster configuration software
- Simultaneous configuration and client software access

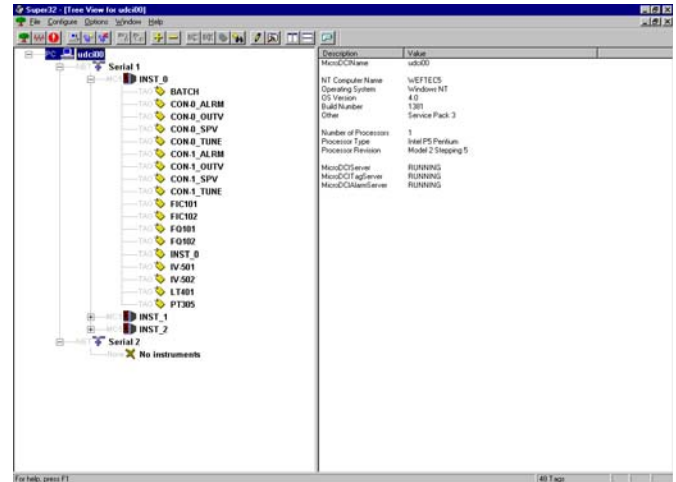

MicroDCI™ Communication Services Software 53SU6000

Introduction

The Micro-DCI Communication Services is the foundation for communication applications involving the Micro-DCI family of controllers. The Communication Services are designed to run under Microsoft® Windows™ 2000 Professional, or Windows™ XP.

The Communication Service can be broken down into several layers or applications each designed to perform a specific function but each tightly woven into a solid set of tools design to simplify the interaction of the user with the controllers.

The principle user interface is an application called Super32. Underlying Super32 is a set of services which automatically scan the user created networks for instrument types and addresses. The result is a network tree which can be collapsed or expanded as need dictates.

Overview

The Micro-DCI Communications Service combines the many elements of communication to the Micro-DCI family of controllers into one transparent user interface tool.

Micro-DCI Communication Service was designed to be user-friendly and perform most of the work based on simple instructions. The **Network Wizard** walks you through the Micro-DCI communication network setup.

Micro-DCI Communication Services will support up to eight individual networks of controllers. The networks can be a combination of serial ports (standard RS-232 or USB), Supervisor ports and Ethernet ports. The number of serial ports and Supervisor ports are limited to four (4) each. The number of Ethernet ports can be up to eight (8).

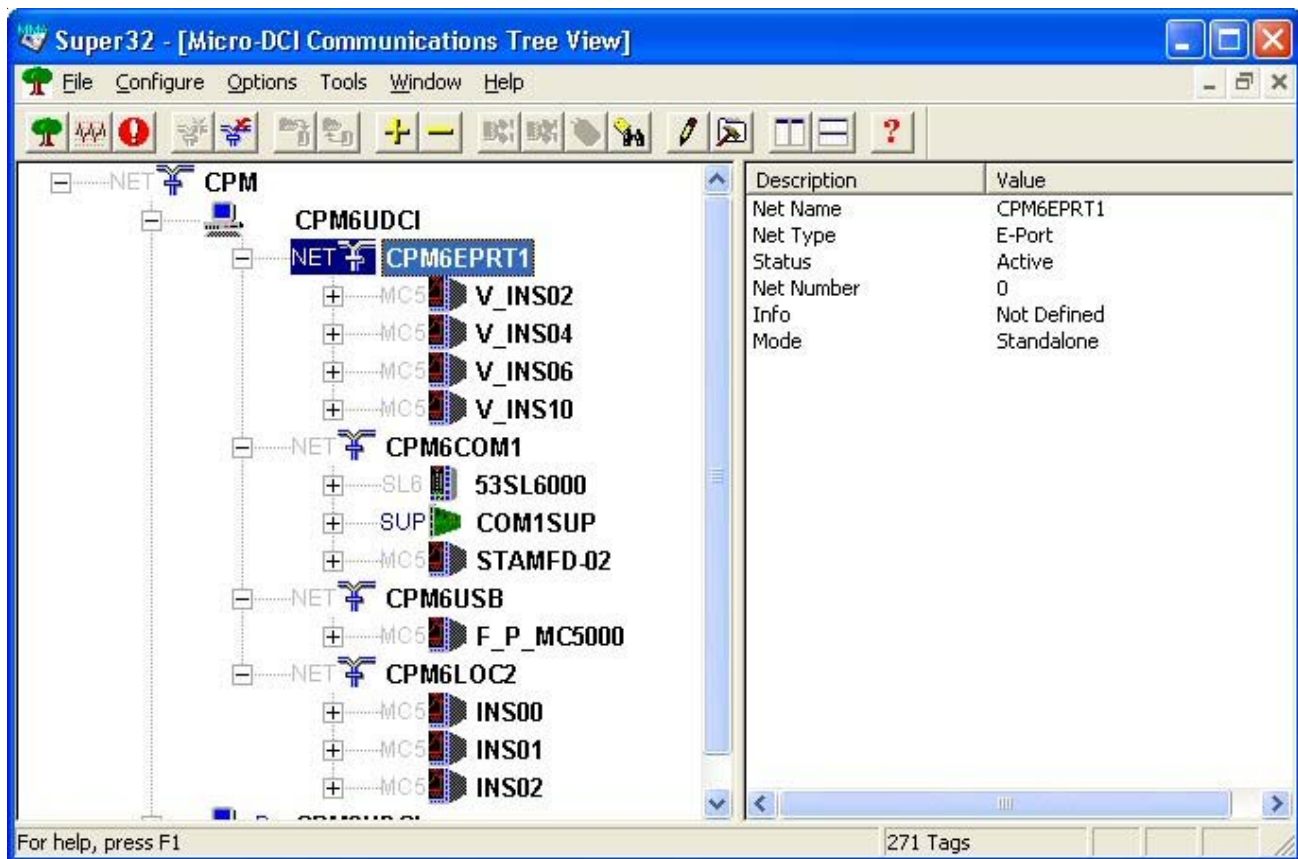

Figure 1 Super 32 Tree View

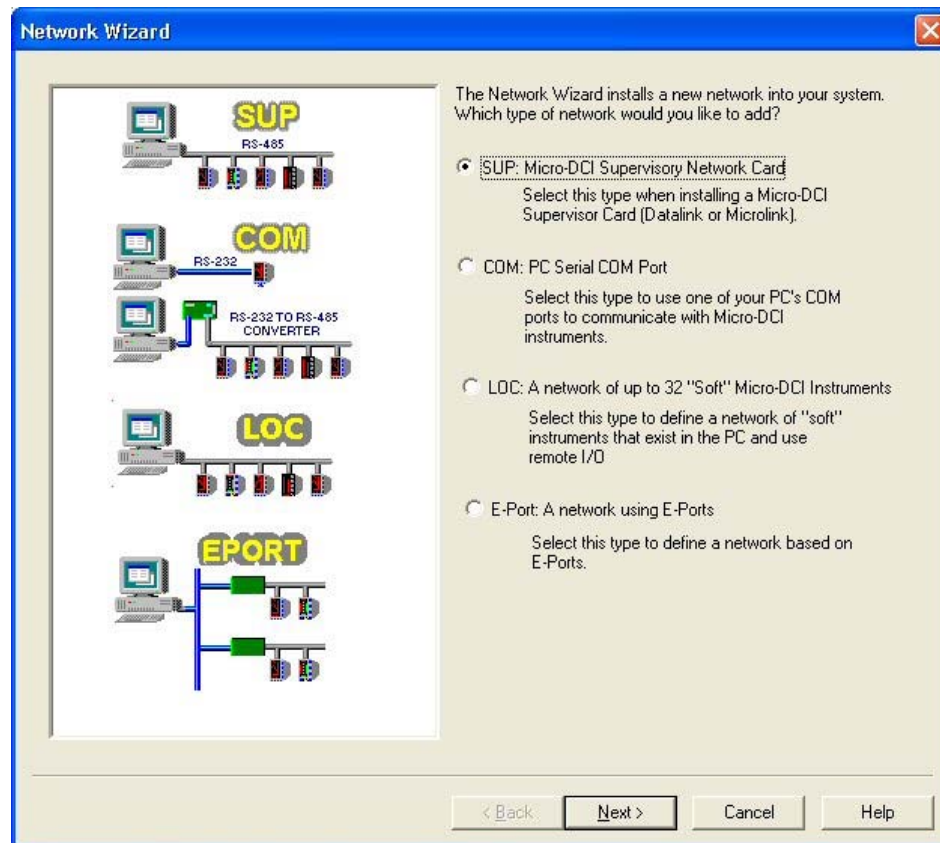

Figure 2 Network Wizard

The PC serial port communications uses the MicroMod Micro-DCI DataLink communications protocol. This communications protocol is standard with each Micro-DCI product. The Supervisor communication card was developed in two versions, DataLink serial protocol and MicroLin high-speed peer-to-peer protocol. Both the DataLink and MicroLink communication protocols are supported by the Supervisor ports. The Ethernet ports support DataLink only.

Each of the eight networks can have up to thirty-two (32) controllers. The controllers can be any of the current generation devices such as 53MC5000 or 53SL6000 or they can be older generation products such as the 50KM1000, 50KM2000, the 53MC1000 53MC2000, or the 53MC4000.

Using the EP1000 E-Port Communications gateway it is possible to physically distribute segments of RS-485 DataLink networks over multiple locations to enhance system performance or create true distributed control architectures. Refer to Specification Sheet S-DCI-EP1000, Ethernet Communications Gateway, for additional details.

Network Wizard

The foundation of the Micro-DCI Communication Services is the implementation of the controller communication networks. These networks are used to gain access to the variety of controller products in the MicroMod Micro-DCI product family. It is thus imperative that the tools for implementing these networks be as simple and straight forward as possible.

The Super32 Network Wizard is the tool for the implementing communication networks. The Wizard provides a five step process to select the type of network desired, name the network, choose whether the network will participate in a Master/Backup configuration, set the network parameters such as baud rate and parity and finish the process by verifying the information you just entered is correct.

Networks can be added or removed at any time and network parameters can be changed as the need dictates.

E-Port Setup and Configuration

The Micro-DCI Communication Services provides the necessary tools to set up the EP1000 E-Port communications gateway configuration. The configuration is accomplished through a built in web page (see Figure 3). Each E-Port is assigned an IP address either manually or using a DHCP server. Each E-Port is then linked to its corresponding host PC through the Super 32 communication network assignment.

Networks of controllers are connected to the EPort's serial communications port via the RS-232/485 ITB. Refer to Specification Sheet S-DCI-EP1000, E-Port Communication Gateway, for additional information on network architecture and communication hardware. The communications baud rate is set from within the configuration window. The configuration window also includes a set of simple diagnostic tools to confirm the connection and communication with controllers attached to the E-Ports serial port.

MicroMod Automation EP1000A E-Port

Ethernet Network Settings

IP address: (10.127.111.194)
Net mask: (255.255.255.0)
Gateway: (10.127.111.15)
DNS server: (10.127.111.33)
E-Port Name:
Description:

Serial Port Settings

Network Name:
Protocol:
Mode:
Baud Rate:
Parity:

Username and Password

User Name:
Password: Leave blank for no password
Repeat Password:

Firmware Version: 1.0.0 Feb 14 2006 OS:1.98

New settings will cause existing connections to be closed

[Diagnostics](#)

Figure 3 Micro-DCI Communication Services E-PORT Configuration

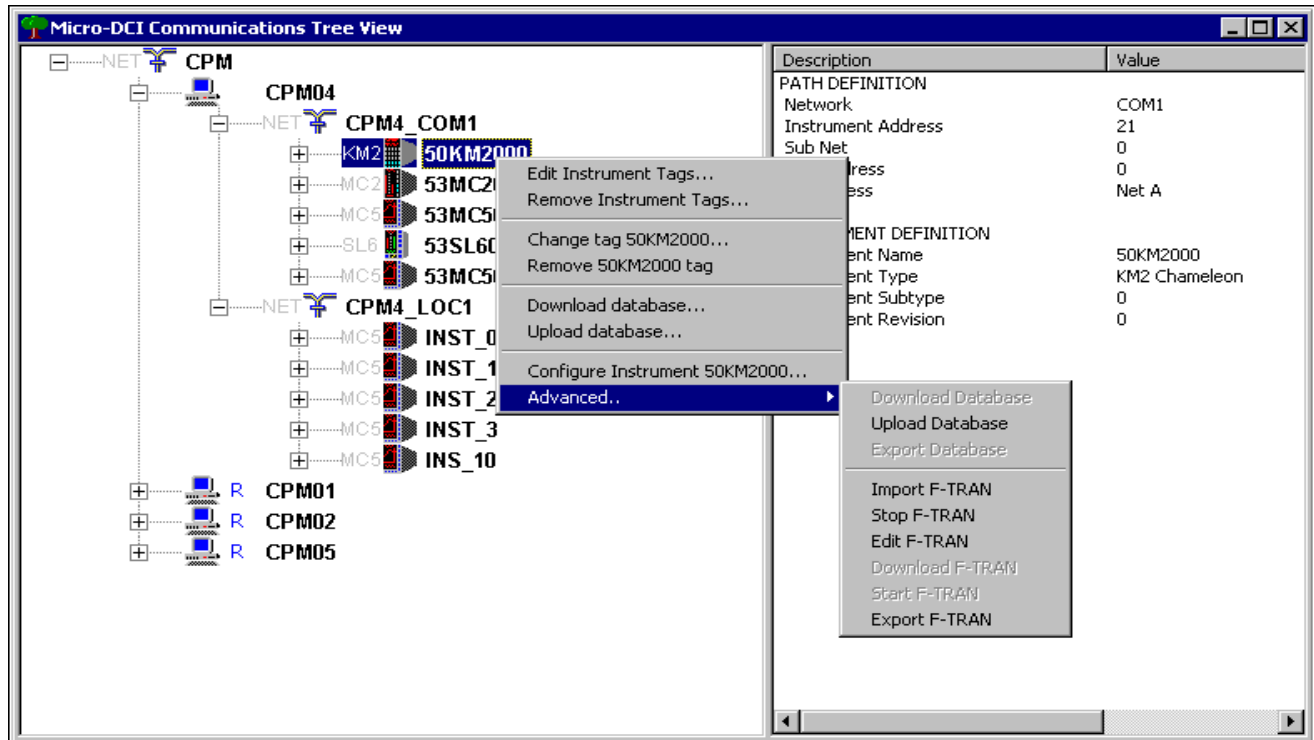

Figure 4 Support Functions

Controller Support

Over the last twenty years, a variety of Micro-DCI controllers have been introduced, many of which are still in use today. The most current version of the Micro-DCI product line is the 53MC5000 Design Level B controller.

The Micro-DCI Communications Services has been designed to provide communication access and support for all generations of the Micro-DCI product line including the 53MC1000, 53MC2000, 53MC4000, 50KM1000, 50KM2000, 53SL6000, 53ML5100, 53IT5100, 53SL5100, 53MC5000A and the 53MC5000B.

Features supported for these controllers include Database Uploading/Downloading, FTRAN programming support such as edit, compile and upload/download, and database configuration. For the 53MC5000A/B and the 53SL6000 controllers, more advanced configuration/programming tools are available (MicroTools and LoopMaster respectively) which can be initiated directly from Super32.

By clicking on the respective instrument, applicable windows will pop up listing options and features available for a particular instrument.

All database information and/or FTRAN programs are maintained in a directory tree with individual program folders for each controller. Controller folder names are created to match the controller tag name. Files within the folder are assigned an appropriate file name and extension.

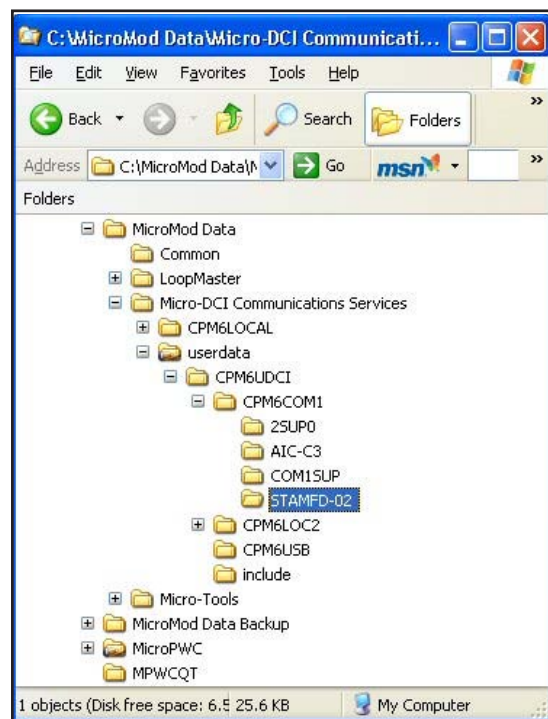

Figure 5 Controller folders

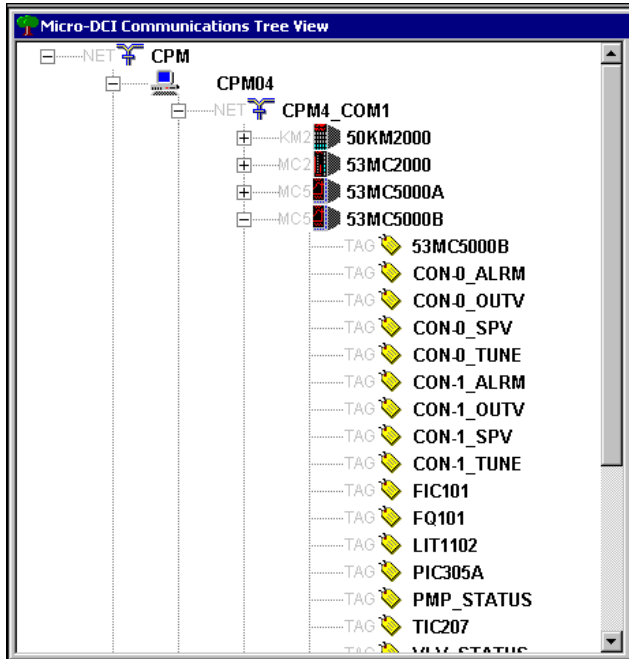

Figure 6 Tag Name Tree

Automatic Tag Recognition

Over time the evolution of the Micro-DCI controllers has included different data types for data storage. One such data type is the alphanumeric or “A” data type. “A” data types are 10 characters in length.

Typical application for the “A” data type is to store information such as engineering units and tag names. In the case of more recent generation of products (53MC5000A & B), these tag names are used as references for specific functions or software modules within the controller.

These software modules may have multiple pieces of information associated with them. This information for say an analog input can be referenced by the analog input module tag name. This information can include the measured value (in engineering units), whether the input is linear or square root extracted, if there is any digital filtering on the input, the input type (0-20 mA or 4-20 mA) and the span and zero references for the input type. Each piece of information will have a reference we call an “atom” that describes the type information being referenced.

The Micro-DCI Communication services employs a special server called a Tag Server that searches all the system networks for all the controller tags and then finds all the tag references in all the controllers.

All the tags, network wide, should thus be unique. Editing tools are provided to search and edit the tagnames within the entire system.

Micro-DCI DDE Server

The Micro-DCI Communications services includes a Dynamic Data Exchange (DDE) server called **udcidde.exe**. DDE is a client/server communications application designed to allow software programs (applications) to share data. A common example of a DDE exchange is cutting and pasting from one computer program to another. Any software application can be both a client and a server. It really depends on your application. Clients usually ask for data while servers provide the data requested.

DDE as it applies to process control is exactly the same. The purpose of the DDE in our situation is to allow real-time data access from the Micro-DCI Instruments to third party DDE clients such as Microsoft Excel.

The Micro-DCI Communication Services includes a DDE server to provide data requested by a DDE client. There is a standard format the data must conform to in order to make the data exchange. In the case of Micro-DCI, the user has access to all module tag names in the controllers. These tag names are made available through the Super32 network application.

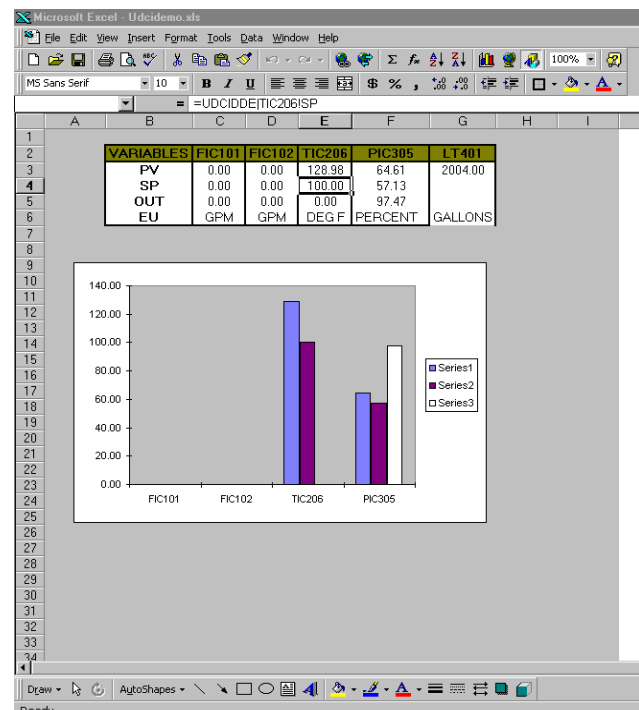

Figure 7 Micro-DCI DDE Server

Micro-DCI OPC Server

Micro-DCI Communication Services software includes the **Micro-DCI OPC Server** (Object Linking and Embedding for Process Control). Object Linking and Embedding is the same Microsoft technology that allows you to exchange information between applications such as Microsoft Word and Microsoft Excel. When applied to the Process Control industry, this technology allows software application in the industrial world to pass information via a common interface.

The OPC interface consists of two parts; a server that provides a hardware/software interface to the instruments and a client which accesses the server and provides data from the controller (via the server) to a user application. The OPC Client is usually directly associated with the user application or is imbedded in the user application. The OPC server is a behind the scenes application. It is normally started when the PC is first started up. There is no server configuration required since the server uses the Micro-DCI Communication services setup to gain access to the controllers.

The client application normally includes a browser that will list all active OPC server applications that are currently running locally (the PC on which the client application is loaded) and remotely (a PC other than that on which the client application is loaded). The browser also typically provides a network tree that displays the available instruments and available data within the instruments. Assigning a particular piece of information from the server to a client requires selection from the tree of available information.

- * Backwards compatible with OPC release 1.0
- * Supports all OPC 2.0 Interfaces except Public Groups and Persistent Files
- * Supports OPC Alarms and Events Version 1.0
- * Provides full access to the Micro-DCI Communication networks created using the Super32 network wizard.
- * Provides access to all Tag.Atom items in all Micro-DCI instruments connected via the Super 32 networks
- * Supports unlimited access to network instruments
- * Allows access to all instrument database values
- * No configuration of the OPC Server required

Direct Access to Configuration Tools

The Micro-DCI Communications Services provides a basic set of configuration tools for all Micro-DCI controller products.

Features supported for all controllers include:

- Database table configuration
- Database Uploading
- Database Downloading

Additional support provided for FTRAN compatible controllers include:

- FTRAN language editor
- FTRAN language compiler
- FTRAN program Uploading
- FTRAN Program Downloading

More advanced configuration/programming tools are available for the for the 53MC5000A/B Process Control Stations, 53SL5100 Single Loop Controllers, 53IT5100 Indicating Totalizer, 53ML5100 Manual Loading Station and the 53SL6000 MicroMite controllers. These tools are directly accessible through the MicroDCI Communication Services. By double clicking the desired controller icon, the appropriate configuration tools can be initiated. MicroTools (53MT6000) has been designed as a Windows 2000/XP based set of configurations tools for the 53MC5000 series controllers, while the LoopMaster software (53HC2600) is the more advanced configuration tools for the 53SL6000 MicroMite controllers.

For more information on these software products refer to the MicroTools and LoopMaster Specifications respectively.

Simultaneous Configuration and Client Software Access

A valuable feature of the MicroDCI Communications Services is its ability to provide configuration access to the controllers while simultaneously maintaining client application software access. No special hardware or setup is required. This is a seamless operation on the part of the Communication Services and there is no need to halt client operations to perform configuration operations on any network

Micro-DCI OPC Local Server

The Micro-DCI OPC Local Server has full access to the Micro-DCI Communication networks created using the Super32 network wizard.

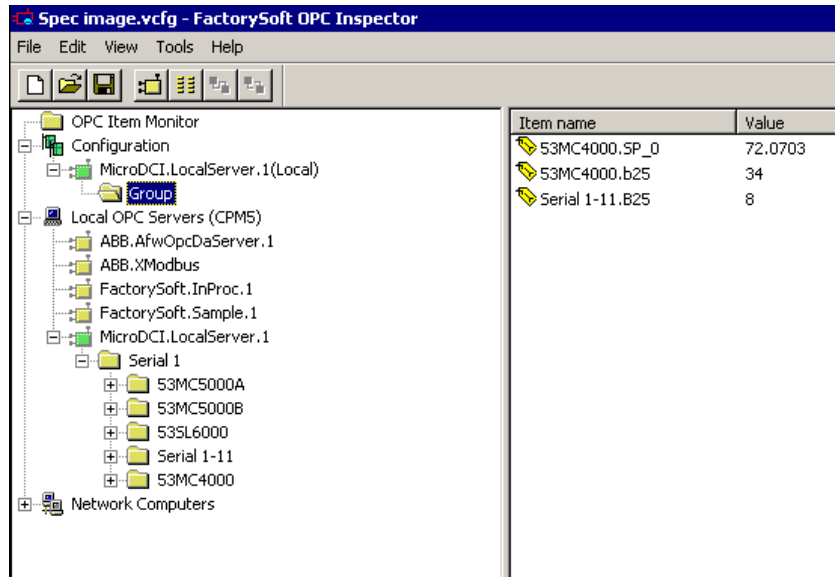

Figure 8 Micro-DCI OPC Local Server

OPC Over Ethernet Local Area Networks (LAN)

A powerful tool of the OPC architecture is its support for OPC servers located on networked PCs. The figure to the right is an illustration of an OPC connection to a MicroDCI controller network located on an ethernet networked PC.

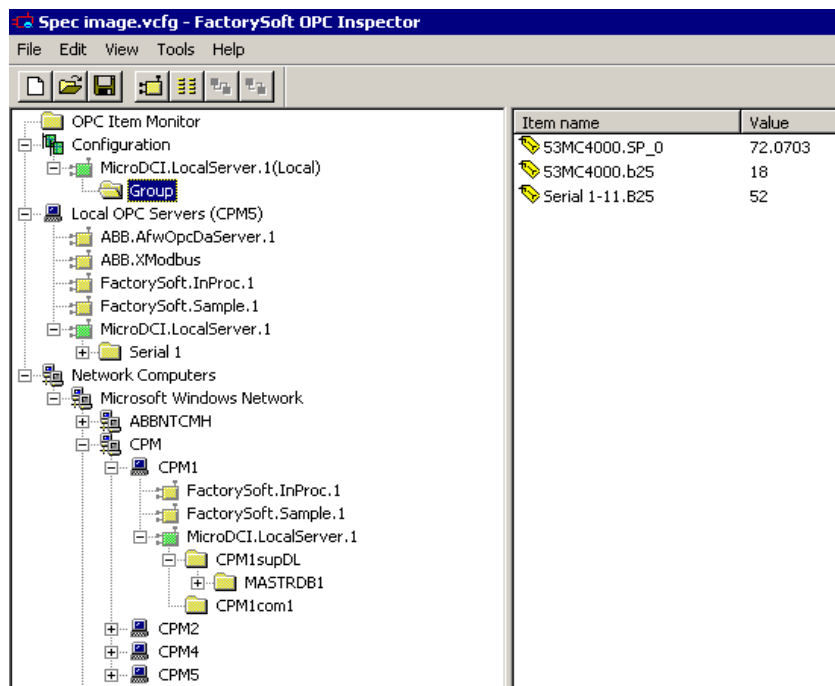

Figure 9 Micro-DCI OPC Server LAN access

MicroTools Model 53MT6000 Configuration Tools

The advanced configuration tools for the 53MC5000 series Process Control Stations.

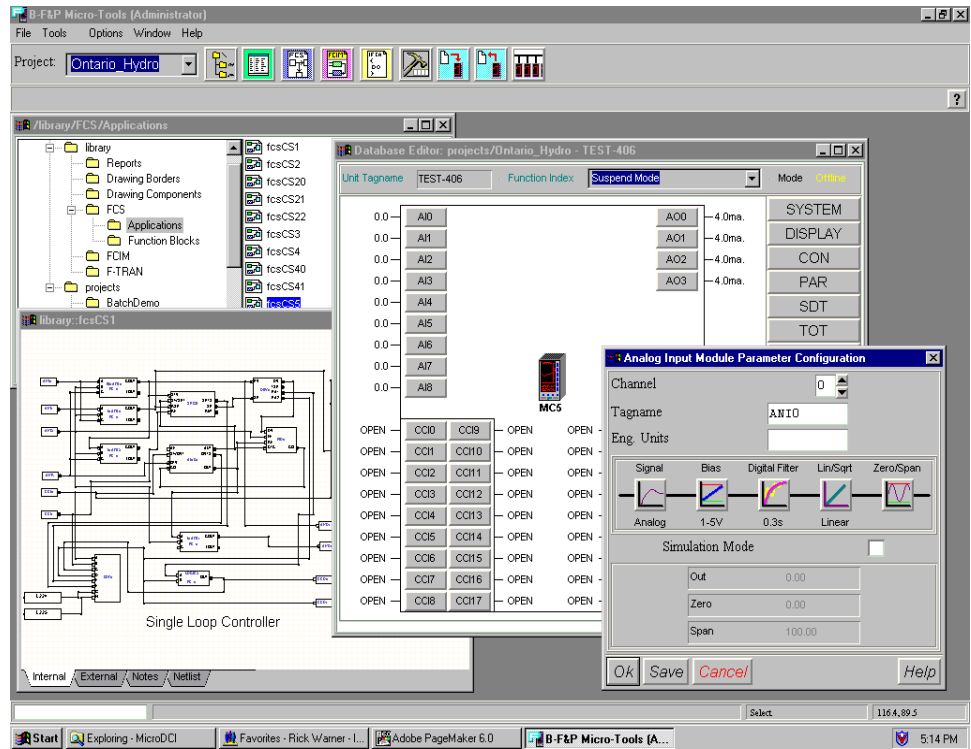

Figure 10 MicroTools Configuration Software

LoopMaster Model 53HC2600 Configuration Tools

The advanced configuration tools for the 53SL6000 series MicroMite controller.

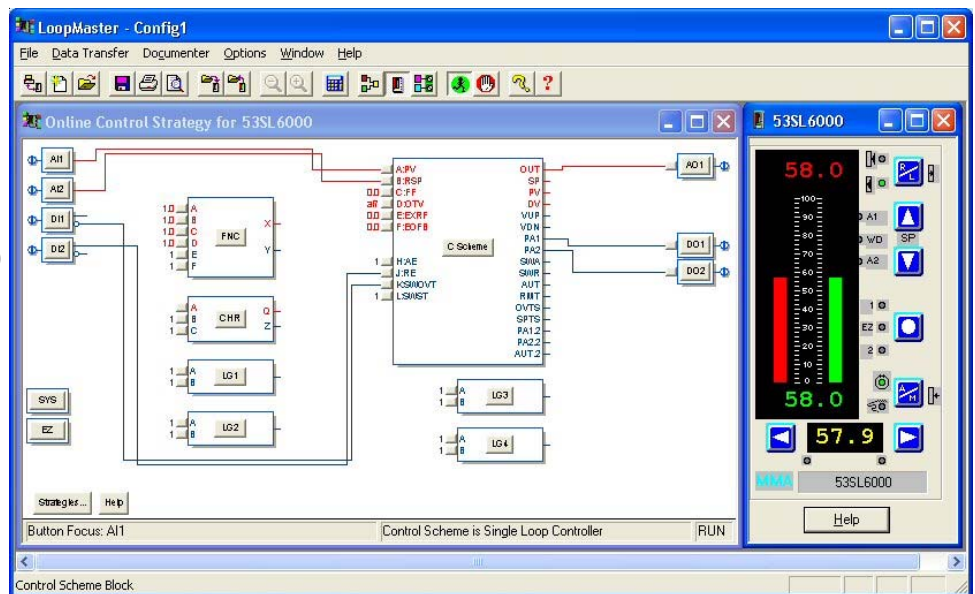

Figure 11 LoopMaster Configuration Software

Model Code	53SU60	—	—	A	—	0
	01 - 06	07	08	09	10	11
Micro-DCI Communications Services <i>For Windows 2000 Professional and XP Professional</i>	53SU60					
Client Interface DDE & OPC DDE & OPC Add-On - <i>for systems with existing Hardware Security key</i>	1 2					
Security Key Type None (<i>for adding to systems with existing Security Device/copy protection key</i>) Parallel Port USB Port		X 0 1				
Design Level				A		
Reserved					X	
Media Type CD-ROM						0

Note: The DDE & OPC server functions provide unlimited access to the controller database regardless of the option selected for the Micro-DCI Global Database Access (GDBA) Database size.

Micro-DCI Communication Services is controlled by a software license manager and matching Hardware Security Device (“copy protection key”) that plugs into either a USB or parallel port on the PC. A device such as a parallel printer may be connected to the parallel port key. Only one Hardware Security device is required when using any MicroMod software product on the same host computer.

Communication between a PC running the 53SU6000 Micro-DCI Communications Services software and the Micro-DCI Instruments (53MC5000, 53SL5100, 53IT5100, 53ML5100, 53SL6000) may be done either via RS-232 to the configuration port connection, through the controller’s RS-485 DataLink communication port or, in the case of the 53MC5000 controllers, through a MicroLink communication port. Applications using MicroLink directly to the PC requires the user of Supervisor communications card. Additional communication hardware and cables may be ordered separately (refer to Price Sheet P-DCI-Spares).

Computer Requirements

The minimum requirements for running the 53SU6000 software are:

Windows™ 2000 Professional/XP Professional

- Intel-based, Windows 2000/XP-compatible personal computer with a Pentium processor of 1 GHz Pentium or higher
- 256 MB RAM
- 200 MB free disk space
- CD ROM drive (software provided on CD)
- IBM AT Compatible 101 key keyboard
- Cursor pointing device such as a mouse or trackball
- Video board and monitor which will support VGA 1024 x 768 display (256-color display minimum)
- 1 - RS232 serial COM port available
- 1 - Parallel port for printing and hardware key installation
- Full size ISA bus slot required for each Supervisor card
- Microsoft Windows™
Windows™ 2000 Professional operating system or Windows™ XP Professional

Notes

www.micromodautomation.com

The Company's policy is one of continuous product improvement and the right is reserved to modify the information contained herein without notice.

Printed in USA

© MicroMod Automation, Inc. 2004



Application-smart control solutions

MicroMod Automation, Inc.
75 Town Centre Dr.
Rochester, NY 14623 USA
Tel: (585) 321-9200
Fax: (585) 321-9291
Email: sales@micmod.com

S-DCI-53SU6000 November 2006